

INSTRUCTIONS

iClick US

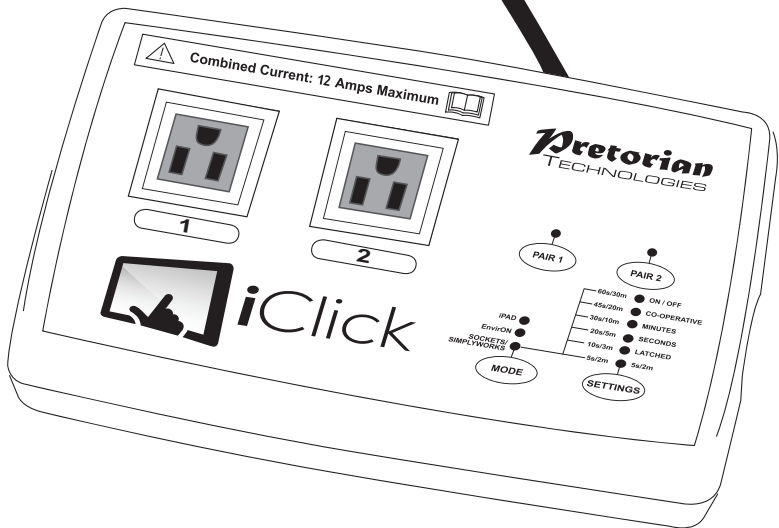

Product Description

iClick is a feature rich mains controller allowing switch users to control up to two electrical appliances with single switches, which may be either wired or wireless. Uniquely, the appliances may also be controlled from an iPad using the free-of-charge iClick app for iPad.

iClick includes both iPad wireless connectivity and SimplyWorks wireless

technology, allowing interference free activation of appliances at up to 20 metres.

Up to seven selectable modes enable the user to choose how, and for how long, the appliance(s) will be turned on. Three modes give independent control of two appliances; four modes provide co-operative control of both appliances.

 The exclamation mark symbol alerts the user to the presence of important instructions in this document.

 Please read this document and any other associated document before using the product.

 Do not dispose of this product in household waste. Many local and municipal authorities operate a recycling scheme for electrical items. Please contact your local authorities for further information.

 This product is designed for indoor use only. Outdoor use presents an electrical shock hazard.

 **Caution: Double-Pole/Neutral fusing.** Terminals inside the unit may still be live when the fuse has activated. Isolate from the mains supply before opening. Return to Pretorian Technologies or refer to qualified service personnel for repair.



IMPORTANT SAFETY INSTRUCTIONS. FAILURE TO COMPLY COULD RESULT IN PERSONAL INJURY.

- Read and pay heed to these instructions and retain for future reference.
- The device may be disconnected at any time by unplugging from the mains supply to which it is attached. Keep the unit sufficiently close to the supply so that disconnection can be effected quickly in the event of an emergency.
- The unit is not an electrical isolation means. You should treat the appliances connected to the unit as capable of being energised at any time, even unexpectedly. Ensure that appliances are unplugged from the unit before attempting any operation which may constitute a hazard, even if the appliance is not energised.
- Do not use this unit near water.
- Unit is intended for indoor use only.
- Regularly examine the unit for any signs of damage, particularly the power cable and the appliance sockets. Do not use the unit if any damage is found.
- Do not attempt to force incompatible plugs into the appliance sockets or to defeat any protective shutters.
- There are no user serviceable parts in the unit. Do not disassemble, and do not attempt to replace a worn or damaged power cable. Refer to an authorised distributor or the manufacturer for all repairs.
- UK units have a further 13A fuse in the plug. Do not replace with fuses of a higher rating under any circumstances.
- Do not use the unit near to sources of flammable gasses or in an explosive atmosphere.
- Electronic Circuit Breakers to protect the unit from overload

Features

- May be operated from wired switches, SimplyWorks wireless switches, Pretorian EnvirON environmental control devices (forthcoming), or an iPad using the iClick free-of-charge app.
- Up to seven selectable control modes. Three modes provide independent switch operation; four provide co-operative switch operation.
- Two 230V, 50Hz sockets (UK and EU units) or two 120V 60Hz sockets (US units).
- Two 3.5mm switch input sockets for wired switches.
- Interference free operation at up to 10 metres distance with SimplyWorks or EnvirON wireless switches or 20 metres with an iPad.
- Operates with wired or wireless switches; or a combination of both.
- On-board memory retains the previous mode and time settings even after power-off.

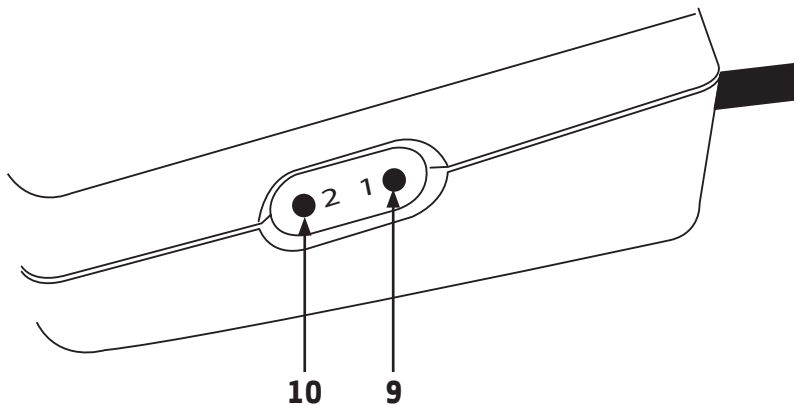
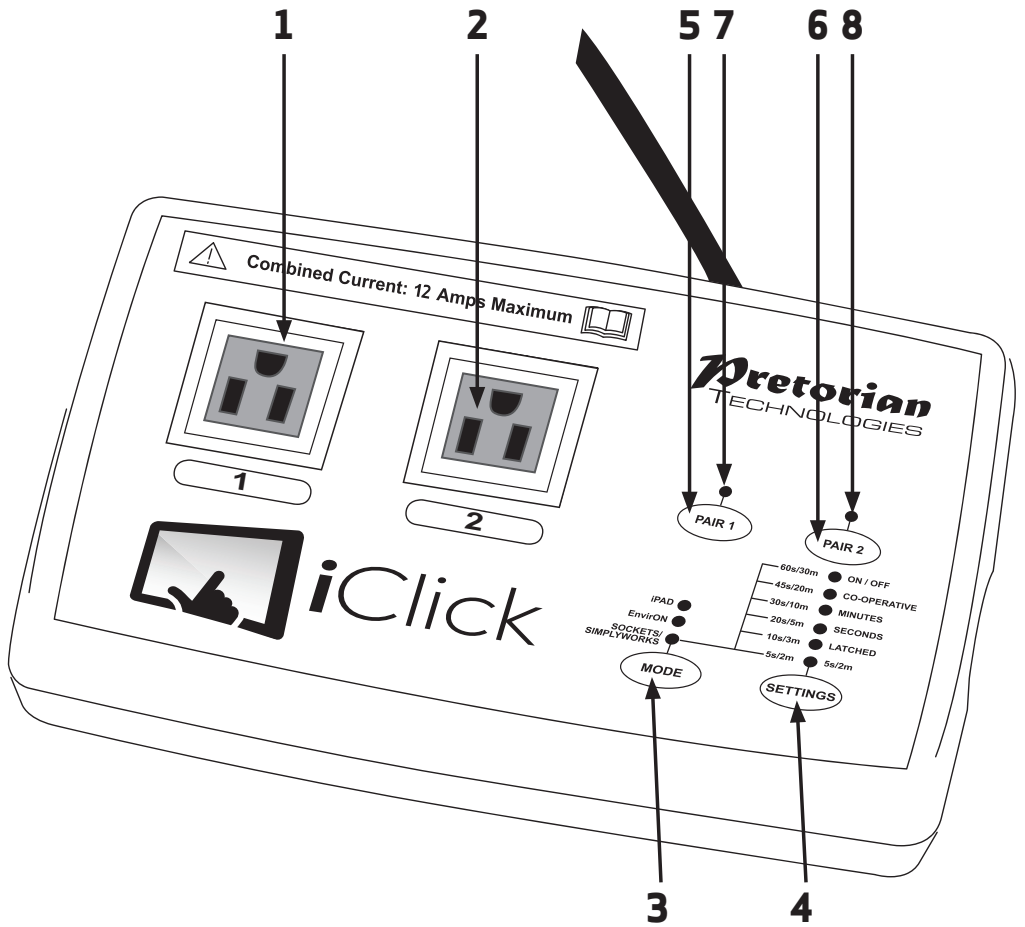

Regulatory Information



Type B Applied Part

This unit has been tested and found to comply with the requirements of EN60601-1 (Electrical Safety of Medical Devices) and is classified as a Type B Applied Part. It has been tested to the following standards:

EN60601-1

EN55022

This equipment has also been tested and found to comply with the limits for a Class B digital device, pursuant to part 15 of the FCC Rules.

These limits are designed to provide reasonable protection against harmful interference in a residential installation. This equipment generates, uses and can radiate radio frequency energy and, if not installed and used in accordance with the instructions, may cause harmful interference to radio communications. However, there is no guarantee that interference will not occur in a particular installation. If this equipment does cause harmful interference to radio or television reception, which can be determined by turning the equipment off and on, the user is encouraged to try to correct the interference by one or more of the following measures:

- Reorient or relocate the receiving antenna.
- Increase the separation between the equipment and receiver.
- Connect the equipment into an outlet on a circuit different from that to which the receiver is connected.
- Consult the dealer or an experienced radio/TV technician for help.

This device complies with Industry Canada license exempt RSS standard(s). Operation is subject to the following two conditions: (1) this device may not cause interference, and (2) this device must accept any interference, including interference that may cause undesired operation of the device.

Le présent appareil est conforme aux CNR d'Industrie Canada applicables aux appareils radio exempts de licence. L'exploitation est autorisée aux deux conditions suivantes: (1) l'appareil ne doit pas produire de brouillage, et (2) l'utilisateur de l'appareil doit accepter tout brouillage radioélectrique subi, même si le brouillage est susceptible d'en compromettre le fonctionnement.

Certificates of compliance available on request.

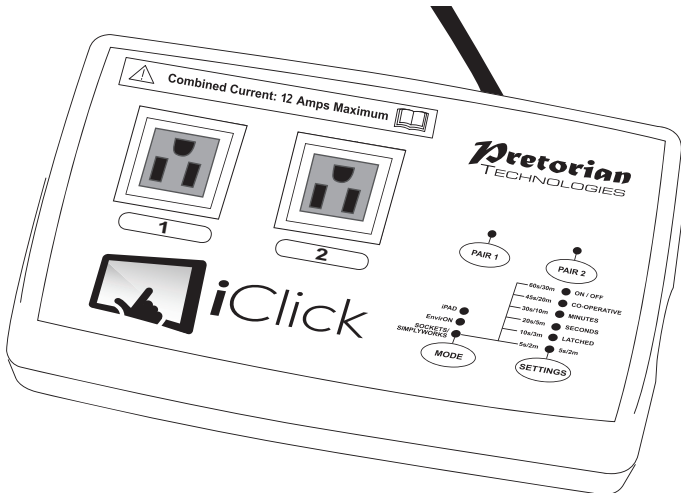

Quick Set-Up

1. Plug the iClick cable into any standard mains socket.
2. Choose between SOCKETS /SIMPLYWORKS; EnvirON or iPad operation by pressing the Mode switch [3] until the relevant LED lights.
3. Plug appliance(s) into the appliance socket(s) [1/2] and turn the appliance(s) on if they have their own power switches.
4. For wired switch operation-simply plug any wired switch into the corresponding socket(s) [9/10]. Set the required function using the Settings button and LEDs
 - For SimplyWorks wireless switch operation- pair each switch with iClick using PAIR1 [5] and/or PAIR2 [6]- see below. Set the required function/ timer period using the Settings button [4].
5. Press the switch(es) or tap the iPad on-screen buttons and the appliance(s) will operate.
 - For EnvirON environmental controls operation- pair the device with iClick using PAIR1 [5] and/or PAIR2 [6]- see below. Set the required function on the switches.
 - For iPad operation tap on the iClick app and ensure it is connected to the iClick (see below). Set the required functionality using the app settings.

The following sections describe in more detail the way in which iClick operates in each of the three operating modes:

SOCKETS / SIMPLYWORKS mode

To enter this mode, press the Mode button [3] repeatedly until the LED adjacent to the 'SOCKETS / SIMPLYWORKS' legend is lit. This LED stays lit to indicate that power is present on the device.

Selecting the Function

Next, choose the operating function for both switches by repeatedly pressing the Settings button [4] *briefly*. The string of LEDs above the Settings button indicates the current selection.

The choices are as follows:

- **DIRECT:** the appliance operates while the switch is held down.
- **LATCHED:** pressing the switch turns the appliance on, pressing the switch again turns the appliance off.
- **SECONDS:** allows the appliance to operate for a preset period of time from 5 seconds to 60 seconds.
- **MINUTES:** allows the appliance to operate for a preset period of time from 2 to 30 minutes.
- **CO-OPERATIVE** (requires 2 switches to be attached): both switches need to be pressed simultaneously to turn both outputs on. Both outputs are turned off when either one of the switches is released.
- **ON/OFF** (requires 2 switches to be attached): switch 1 turns on both appliances; switch 2 turns both off.

Once the required function has been chosen, the LEDs are extinguished after a few seconds and the new settings become active. They are also retained in the unit's memory for next time the unit is powered on.

If SECONDS or MINUTES has been selected, the required time period must also be set. To achieve this, **press and hold** the Settings button [4] until the adjacent LEDs light. The time period can be read from the highest LED to be lit.

For example, if all the LEDs up to and including 5m are lit when MINUTES is selected, each socket is independently timed for 5 minutes when its respective switch is pressed. A timed period may always be curtailed by pressing either PAIR1 (for socket 1) or PAIR2 (for socket 2).

Note that both sockets always use the same function setting. For example, if you select 'DIRECT', each socket will activate when its respective switch is pressed and deactivate when its respective switch is released.

When the unit is set to a co-operative function such as CO-OPERATIVE or ON/OFF, both sockets operate simultaneously when the condition is met. For example, if the unit is set to CO-OPERATIVE function and both switches are pressed and then released, both sockets 1 and 2 will turn on and off simultaneously.

Using iClick with wired switches.

To use iClick with wired switches, first ensure that the unit is set to SOCKETS / SIMPLYWORKS mode and then plug the switches into the sockets [9/10] on the side of the unit.

Using iClick with SimplyWorks switches

To operate the appliance(s) with SimplyWorks switches, first ensure that iClick is set to SOCKETS / SIMPLYWORKS mode. It is then necessary to pair each switch with iClick, using the following procedure:

Place the wireless switch close to iClick and briefly press either the PAIR1 button [5] or PAIR2 button [6] on iClick to pair with socket 1 or 2 respectively. PAIR1 or PAIR2 LED [6/7] will flash slowly. While the LED is flashing, press the Pair button on the switch. The relevant pair LED on iClick will continue to flash slowly until pairing is complete when the LED will light steadily for approximately 5 seconds.

Any SimplyWorks transmitting device may be paired with iClick, the procedure being exactly as described above. For example, SimplyWorks Send may be used to make a wireless connection with any kind of wired switch such as squeeze switches, pillow switches etc. It is also possible to pair a SimplyWorks Joystick, in which case the stick becomes a 'wobble switch'. Smooth Talker can also be used to turn on an appliance if the 'reward' output is selected for a particular message. The SimplyWorks concept opens up almost endless possibilities.

Whenever iClick receives a wireless transmission, the relevant Pair LED [7/8] blinks briefly as an acknowledgement. This is useful when finding which switch is paired with a particular socket.

EnvirON mode

EnvirON is Pretorian Technologies' forthcoming range of Environmental Controls and includes products such as scanning remote controls which can operate battery powered appliances, mains powered appliances or infra-red products such as TVs.

Any EnvirON product may be paired with iClick to allow it to control mains-powered devices. To enter EnvirON mode, press the Mode button [3] repeatedly until the LED adjacent to the 'EnvirON' legend is lit. This LED stays lit to indicate that power is present on the device.

To operate the appliance(s) with EnvirON devices, first ensure that iClick is set to EnvirON mode. It is then necessary to pair each device with the iClick, using the following procedure:

Place the device close to iClick and briefly press either the PAIR1 button [5] or PAIR2 button [6] on iClick to pair with socket 1 or 2 respectively. PAIR1 or PAIR2 LED [6/7] will flash slowly. While the LED is flashing, press the Pair button on the EnvirON device. The relevant pair LED on iClick will continue to flash slowly until pairing is complete when the LED will light steadily for approximately 5 seconds.

Unlike SimplyWorks devices where the function is set using the Settings button [4], EnvirON devices send function information each time they send data. The function is therefore set on the transmitting device on not on iClick. A full range of Direct, Latched, Timed and Co-Operative settings are possible- please refer to the instructions for each EnvirON device for details.

As a result, the Settings button [4] and its associated LEDs do not operate in EnvirON mode.

Note that whenever iClick receives a wireless transmission, the relevant Pair LED [7/8] blinks briefly as an acknowledgement. This is useful when finding which switch is paired with a particular socket.

iPad Mode

Uniquely among assistive technology equipment, iClick can connect to an iPad via the associated app (also called iClick) to allow users to control appliances using on-screen buttons.

You must first download the free-of-charge iClick app from the Apple App Store. The adjacent QR code can be used to take you directly to the relevant page of the App Store, or you can simply search for iClick or Pretorian. The app is free of charge.

Please Note - Requires iPad 3, iPad Mini, iPad Air, iPad Pro or later. Will not work with First Generation iPad or iPad 2.

To operate the appliance(s) with an iPad, first ensure that the iClick product is set to iPad mode by repeatedly pressing the Mode button [3] until the LED adjacent to the 'iPad' legend lights. If an iClick has previously been connected and is still available, the connection will be restored automatically and the LED will light continuously. If the LED blinks, this is an indication that it is not currently connected to an iPad and the following connection procedure must be followed:

Making a connection between an iClick product and an iClick app is carried out within the app and NOT from iPad Settings. First tap on the  icon in the app. You can see whether a device is already connected and if so, which, from the first item on the screen. If there's no connection it will appear like so:





However, if a device is already connected, it might appear like so:

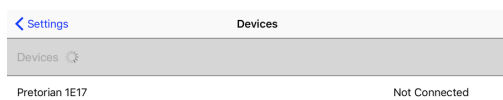

The combination of four characters appended to the product name is a unique code that allows you to identify the device that's connected even in a room full of similar devices. On the base of iClick is a label bearing a four character code and this code corresponds with what's shown on screen.



To connect a particular iClick, first observe its 4-character code and then look for it on screen. Tap on it and it will connect. The iPad LED will now light continuously to indicate that a connection has been made and the app is now ready to control the appliance(s).

The function of each button on screen, and the number and appearance of the buttons, is set using the app settings. Tap on the  icon and set up each button as required. Further information is available in the on-line app help guide, also available from the  icon.

Note that, for reasons of safety, the sockets may be turned off at any time from the app simply by tapping the **All Off** icon. This works immediately, irrespective of the Delayed Access setting. If for reasons of electrical interference, for example, the app loses contact with the iClick, the iClick may simply be unplugged from the wall at any time.

BUTTON 1 MODE

Direct	i	✓
Latched	i	
Timed	i	
Co-Operative Direct	i	
Co-Operative Latched	i	
Co-Operative Timed	i	
On/Off	i	

BUTTON 2 MODE

Direct	i	✓
Latched	i	
Timed	i	
Co-Operative Direct	i	
Co-Operative Latched	i	
Co-Operative Timed	i	
On/Off	i	

TIMER PERIOD

Timer Period 45 sec



BUTTON APPEARANCE

2 Dimensional (Flat)

3 Dimensional



BUTTON SUMMARY

1		36pt
2		36pt
Button 2 visible on screen	<input checked="" type="checkbox"/>	

DELAYED ACCESS

Immediate	i	✓
Delayed	i	

INFO

Help

About

Other Features

Output Status

The Pair LEDs also indicate the status of the output sockets [1/2]. If channel 1 is activated, Pair LED 1 [7] lights and if channel 2 is activated, Pair LED 2 [8] lights. The LEDs still blink briefly if a wireless transmission is received.

Turning Sockets off

If a socket is set to a timed mode, the period for which the appliance is energised may be ended prematurely by pressing either the relevant Pair button [5/6] briefly, irrespective of setting.

Maintenance

Before undertaking any cleaning or inspection unplug iClick from the mains supply. Periodically check the unit to ensure there is no damage to the cable.

Do not use iClick if the cable has been damaged or the unit is wet. Clean using a dry cloth, never immerse in water or spray water or other liquids on to the unit. Never carry iClick by its power cable. Your organisation may require iClick to be tested periodically for continued electrical safety. This is statutory in some countries.

iClick has no user serviceable parts. If repair is necessary the unit should be returned to Pretorian Technologies Ltd or an authorised distributor.

Electronic Circuit Breakers

iClick is protected by two circuit breakers on the underside of the unit. If the maximum load is exceeded the circuit breakers will trip and the buttons extend beyond their normal position. Before resetting the circuit breakers, it is very important to review the configuration of appliances and eliminate excessive loads or any faulty equipment that might have given rise to the trip condition. Only once this has been carried out should the circuit breakers be reset by pushing the button(s) back in. If in doubt, refer to a qualified electrician.

Safe Operation



Your safety, and that of the people around you, is of paramount importance. Please read these guidance notes to ensure that the unit, and the appliances that are connected to it, are operated in a safe manner.

- Ensure you are familiar with the appliances you plug into iClick by reading their operator's manual and/or using them separately to begin with.
- If an appliance can cause injury due to rotating parts, sharp blades or similar, unplug it from iClick before exposing the parts which might cause injury. For example, unplug a food processor from iClick before lifting the lid.
- Remember that lamps create heat when energised. Ensure that they are not close to any combustible material and that they are not accessible to touch.
- Power cables can be a trip hazard- ensure they are kept off the floor. Do not allow cables to hang over the edge of a work surface where children can pull on them.
- Wherever possible, keep iClick out of sight of the user since it can be a dangerous distraction from the activity being taught.
- Whilst iClick uses state of art wireless technology to communicate with wireless switches and the iPad, it is still possible for appliances to be energised unintentionally, or for an appliance to fail to be turned off when required. Ensure the unit is switched off when not in use.
- Never operate the unit near to water.
- Never open the unit or attempt any kind of repair.
- Do not allow the user to turn the load on and off rapidly by clicking repeatedly on the switches. This could damage the appliance and the iClick.

Warranty

iClick is warranted against defects in manufacture or component failure. The unit is designed for use in domestic, educational, health and commercial applications. Use outside these areas will invalidate the warranty.

iClick is not authorised for use with safety critical, mission critical or life/health sustaining apparatus of any kind.

Unauthorised repair or modification, mechanical abuse or immersion in any liquid will invalidate the warranty.

Technical Specification

Input/Output Power:

UK and Europe: 230VAC, 10A*, 50Hz USA: 120VAC, 10A*, 60Hz

** refers to the total of all connected appliances.*

Fuse Ratings:

UK: 13A fuse in plug.

EU: No fuse in plug.

USA: No fuse in plug.

All types: 0.2A time delay TR5 fuse on pcb.

This fuse should only be changed by qualified service personnel.

Never exceed the fuse ratings quoted above. If in doubt refer to qualified service personnel.

Ingress rating: IP30.

Troubleshooting

Symptom	Possible Cause	Remedy
No power to iClick	<ul style="list-style-type: none">• Not plugged into wall socket• Wall socket not functioning• Circuit breakers tripped	<ul style="list-style-type: none">• Plug unit in!• Check household fuses/ circuit breakers. Replace or reset if necessary• Check both circuit breakers on underside of unit and also 13A fuse if unit is fitted with a UK plug.
Wired switch does not operate appliance	<ul style="list-style-type: none">• Switch lead broken• Switch not plugged into correct socket• Unit not set to SOCKETS/ SIMPLYWORKS mode• Unit is set to a CO-OPERATIVE or ON/OFF functions• Appliance not functioning• Appliance has its own power switch	<ul style="list-style-type: none">• Test with Pretorian Test-IT and replace if necessary• Change to correct socket• Set unit accordingly• Change to another function• Plug into a separate wall socket to test. Replace if necessary.• Ensure that switch is set to on.
SimplyWorks switch does not operate appliance	<ul style="list-style-type: none">• Unit not set to SOCKETS/ SIMPLYWORKS mode• Switch not paired (watch for Pair LED blinking).• Unit is set to CO-OPERATIVE or ON/OFF functions• Appliance not functioning• Appliance has its own power switch	<ul style="list-style-type: none">• Set unit accordingly• Follow pairing sequence for required socket.• Change to another function• Plug into a separate wall socket to test. Replace if necessary.• Ensure that switch is set to on.
EnvirON switch does not operate appliance	<ul style="list-style-type: none">• Unit not set to EnvirON mode• Switch not paired (watch for Pair LED blinking).• Unit is sending a function that is not conducive with turning on, for example set to 'OFF' function• Appliance not functioning• Appliance has its own power switch	<ul style="list-style-type: none">• Set unit accordingly• Follow pairing sequence for required socket.• Change to another function• Plug into a separate wall socket to test. Replace if necessary.• Ensure that switch is set to on.
Appliance does not turn off using switch	<ul style="list-style-type: none">• Unit may be set to a timed mode.• Unit may be set to On/Off mode.	<ul style="list-style-type: none">• Check mode setting and change if necessary.• Check mode setting and change if necessary.

